

Safety Considerations

This product and related documentation must be reviewed for familiarization with safety markings and instructions before operation.

Safety Symbols The following symbols may be found on the remote control or throughout the remote control's documentation.



Refer to Manual
When product is marked with this symbol refer to instruction manual for additional information.



High Voltage
Indicates presence of hazardous voltage. Unsafe practice could result in severe personal injury.



Protective Earth Ground
Indicates protective earth terminal.



Warning
Denotes a hazard. Included text gives proper procedures. Failure to follow instructions could result in severe personal injury and / or property damage.



Caution
Denotes a hazard. Included text gives proper procedures. Failure to follow instructions could result in minor personal injury and / or property damage.

Warranty
Gain Electronic Co., Ltd. guarantees that this product meets its published specification at the time of shipment from the factory. Under proper installation it should work as expected. However, GAIN does not guarantee that operation in SAGA1 system is error free or without intermission.

This equipment is warranted against defects in material and manufacturing for a period of one year from the date of shipment. During the warranty period, GAIN is responsible for necessary repairs as long as the product can be proved to be defective.

For warranty service or repair this product must be returned to a service facility designated by GAIN. Buyer will pay shipping charges to GAIN while GAIN will pay return shipping charges.

This warranty does not include consumptive parts such as batteries, fuses, buttons, relays. Also this warranty does not cover defects caused by improper installation, improper or insufficient maintenance, unauthorized modification, improper operation, ignorance of environmental specifications, or improper software or interfacing.

No other warranty is expressed or implied, except for the above mentioned.
The remedies provided herein are the buyer's sole and exclusive remedies.
GAIN shall not be liable for any direct, indirect, special, incidental or consequential damages.

CONTENTS

Safety Considerations

Warranty

1.0 Standard Accessories for SAGA1-L Series..... P.1

2.0 Specification..... P.2

3.0 Emergency Procedures..... P.4

4.0 General Operation..... P.5

5.0 Receiver Voltage Selection P.6

6.0 Change Of Fuse..... P.7

7.0 ID Registration..... P.8

8.0 Changing the Frequency..... P.9

9.0 Batteries..... P.10

10.0 LED Malfunction Alert..... P.11

1.0

Standard Accessories for SAGA1-L Series

Open the shipping carton and get a standard SAGA1-L Series, it includes the following item:

1. Transmitter, one unit
2. Receiver, one unit
3. User's Guide, one unit

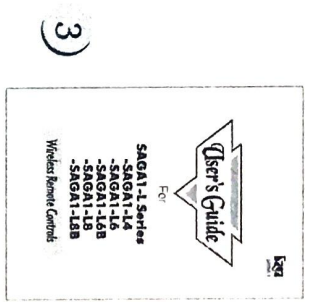
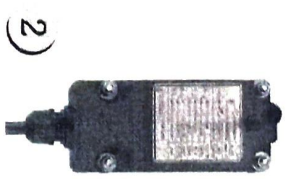
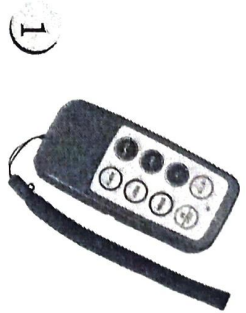

2.0

*** SPECIFICATION**
1) General:

1. Enclosure: IP65	5. ID Code: 32bit
2. Structure: Glass Fiber	6. Hamming distance ≥ 4
3. Operating Temperature: -45 ~ +80°C	7. Static > 15KV
4. Relay: 5A/250VAC (AC Power); 10A/36VDC (DC Power)	8. ID Code Registration
	9. Operating range: up to 100M

2) SAGA1-L series:

- * L4: 4 pushbuttons with 1-step (Start, Stop, Up, Down,)
- * L6: 6 pushbuttons with 1-step (Start, Stop, Up, Down, East, West)
- * L6B: 4 pushbuttons with 2-steps (Up, Down, East, West) + EMS + Start Key
- * L8: 8 pushbuttons with 1-step (Start, Stop, Up, Down, East, West, South, North)
- * L8B: 6 pushbuttons with 1-step (Up, Down, East, West, South, North) + EMS + Start Key

3) Transmitter:



SAGA1-L4



SAGA1-L6



SAGA1-L8

1. L x W x H: 120 x 55 x 25mm	6. Shock resistance
2. Weight: 155g (w/batteries)	7. Output power $\leq 4mW$
3. 2 AA size alkaline batteries	8. Normal power consumption < 10mA
4. Low power indicator (LED flash red)	9. Sleep mode consumption: less 1 μA
5. Pushbutton jammed detector	10. Modulation: FM

2

2.0



SAGA1-L6B



SAGA1-L8B

1. L x W x H : 163 x49x 45mm	6. Shock resistance
2. Weight: 250g (w/batteries)	7. Output power $\leq 4mW$
3. 2 AA size alkaline batteries	8. Normal power consumption < 10mA
4. Low power indicator (LED flash red)	9. Sleep mode consumption: less 1 μA
5. Pushbutton jammed detector	10. Modulation: FM

4) Receiver



1. L x W x H : 161 x74 x 52mm	6. Independent COM Line
2. Weight: 1100g (w/out cable)	6-1. 4 independent COM Line U/D, E/W, S/N RO for SAGA1-L8, SAGA1-L8B
3. AC type: 24/48, 48/110, 48/220, 110/220, 220/380VAC	6-2. 3 independent COM Line U/D, E/W, RO for SAGA1-L6
DC type: 12V ~ 24VDC	6-3. 2 independent COM Line U/D, RO for SAGA1-L4
4. Sensitivity: about -105dBm	6-4. 2 independent COM Line U/D ~ E/W and RO for SAGA1-L6B
5. Shock resistance	

3

3.0

EMERGENCY PROCEDURES

In case of any emergency occurred, please:

- 1) Press STOP pushbutton
* For SAGA1-L6B/L8B: Press EMS button and remove the key.
- 2) Switch off the main power of crane and then contact your local distributor for the service and find out the reason.

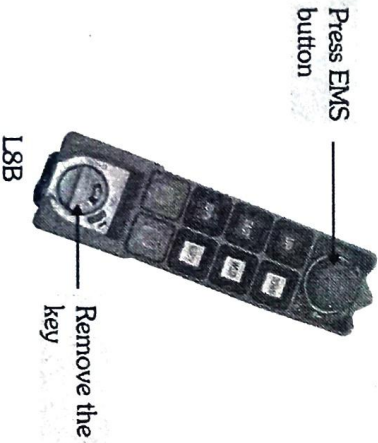
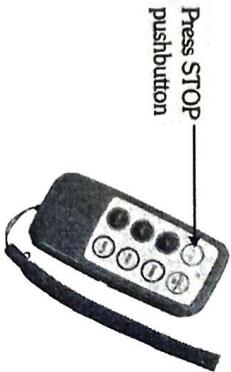

4

4.0

GENERAL OPERATION

- 1) Turn-on the main power switch of the equipment (Crane)
- 2) Install two AA size Alkaline batteries in the transmitter
- 3) Press the Start/R0 pushbutton to turn on the main relay inside receiver
* For SAGA1-L6B/L8B: a) Releases the EMS button
b) Turn the key clockwise to "ON" Position
c) Continue to turn the key clockwise to "START" position to Power-On
- 4) Operate normally according to the function setting have been done
- 5) Please proceed the following procedures after operation:
 - a) Press STOP pushbutton
 - b) Put the transmitter in place
 - c) Switch Off the main power switch of the equipment (Crane)

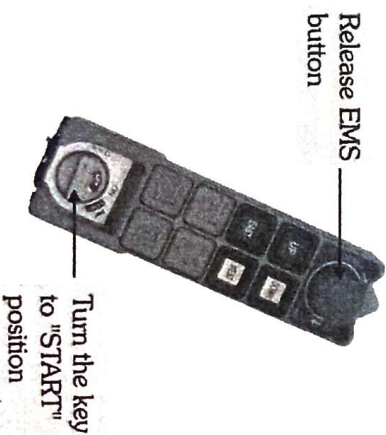
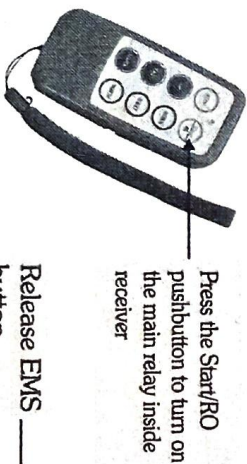

5

5.0



RECEIVER VOLTAGE SELECTION

There are two types of power voltage (DC and AC) available for the SAGA1-L Series:

1) DC Type:

Input Voltage : 12~24VDC
Relay Contact: 10A-36VDC,

2) AC Type

5 different transformers: 24/48V, 48/110V, 48/220V, 110/220V, 220/380V)

The voltage selection jumper is:

	LO	HI
AC24/48V (TRANSFORMER)	24	48
AC48/110V (TRANSFORMER)	48	110
AC48/220V (TRANSFORMER)	48	220
AC110/220V (TRANSFORMER)	110	220
AC220/380V (TRANSFORMER)	220	380

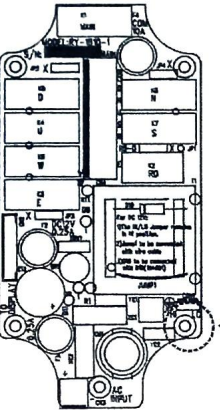
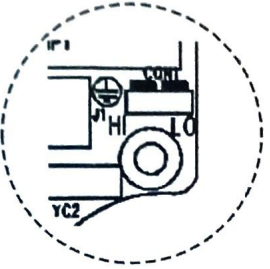

6

6.0

* CHANGE OF FUSE

1) DC Type

Unplug the yellow one fuse 20A to replace with a new one.

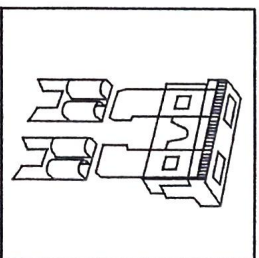

2) AC Type

Depress the fuse cover and turn counter-clockwise with a flat screwdriver to open up the fuse cover. Then remove the old fuse and insert the new correct fuse into the cover first. Place this fuse along with cover into the fuse holder base, and depress the fuse cover and turn clockwise with flat screwdriver.

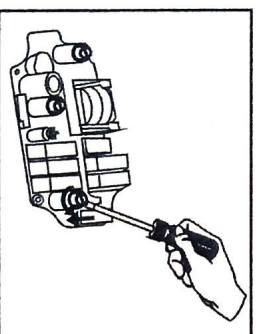

7

7.0

* ID REGISTRATION

ID Registration allows you to pair the new TX or RX if one of them is damaged. In order to work the TX & RX must have the same ID codes and frequency. Using ID Registration will make both the TX and RX to have the same ID codes.

1) Please make sure the following conditions before ID Registration:

- (a) Both TX and RX are of the SAME model and frequency.
- (b) To place the transmitter as close as possible to the receiver to avoid any interference.
- (c) Turn off the RX power more than 10 seconds and turn it on again.
- (d) Complete the ID Registration within 4 minutes after turning on the RX. The RX will NOT accept the ID Registration signal after 4 minutes.

2) ID Registration Instructions:

- (a) Press and hold the transmitter STOP pushbutton / EMS button.
- (b) Press DOWN pushbutton and hold it.
- (c) Press UP pushbutton 4 times and release "STOP & DOWN" pushbuttons when the red light on the transmitter is flashing.
- (d) Start the system as usual.

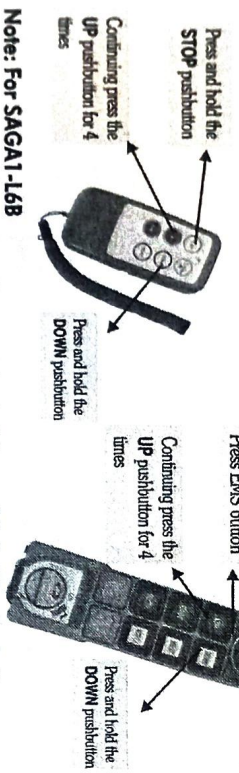

Note: For SAGA1-L6B

- 1. The **Down** pushbutton must be remaining in 1st step while holding the button.
- 2. Press **UP** pushbutton till **1st step** continuing for 4 times. Do not press button into 2nd step while proceeding this instruction otherwise the ID registration will be aborted.

ATTENTION:

- * In case ID Registration fails, repeat the instructions above within 4 minutes.
- * ID Registration is available for ID code only. It will not change function settings.
- * Within the operating distance, all same model systems on the same frequency will be paired with the transmitters ID code.

8.0

* Change the Frequency

It's simple to change frequency of the SAGA1-L series. The system's frequency can be changed simply by replacing correspondent frequency quartz in both TX and RX.

Instructions:

- (1). Pry up the quartz unit with a flat screwdriver.
- (2). Remove the quartz unit from the system.
- (3). Use a needle nose pliers to straighten both pins of the new quartz unit.
- (4). Insert new quartz unit vertically into PC board.
- (5). Press new quartz unit down into the socket.

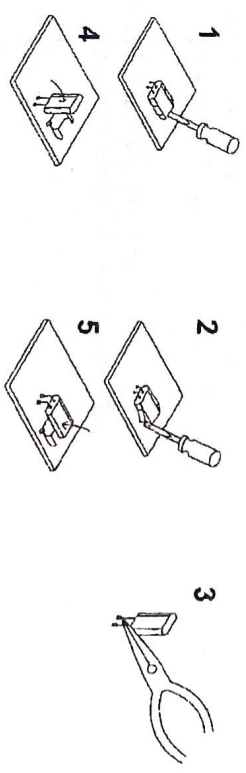

Note: The frequency will be different when plugging the same quartz unit into TX or RX, for example,

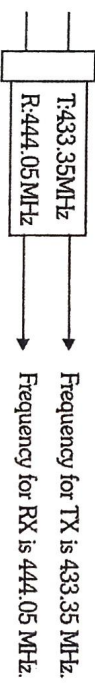

9.0

* BATTERIES

Two AA size alkaline batteries are required for the transmitter. The LED will flash green when the battery power is sufficient. The LED will flash red when the battery power is low.

- * The operating distance will become shorter and intermittent when the battery is low.
- * Replace with new battery when battery power is low.

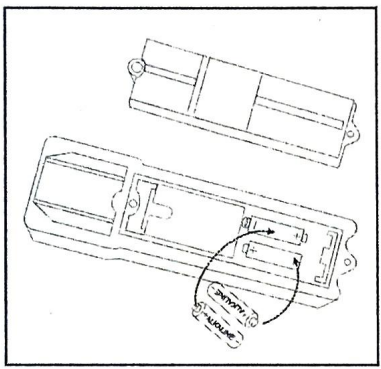
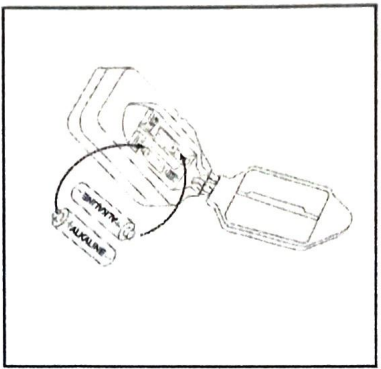

Don't use rechargeable batteries.

10.0



LED MALFUNCTION ALERT

* If a problem listed below is found, please contact the distributor for repair.

- (1) **Red LED flashing quickly (every 0.2 sec) when any pushbutton is pressed.**
The problem could be:
 - (a) One of the pushbuttons is jammed.
 - (b) The system is not properly powered according to the instructions.
- (2) **TX LED flashes slowly (every 0.5 sec).**
The memory of the TX is defective.
- (3) **RX Error LED flashes slowly (every 0.5 sec).**
The memory of the RX is defective.
- (4) The operating distance is shorter or an intermittent operation is happened.



In regard to the installation or others, please refer to the Installation & Operation Manual.

P.S.: Please direct contact the local distributors for the after service or if you have a problem with the remote controls as well, or fax to 886-7-8157253.